



# Broadland Gardens, Plymstock

Green. Family. Future.



# Welcome to Broadland Gardens

Broadland Gardens offers you the chance to live in an exceptional family home that will grow and adapt to whatever life throws at you. With a commitment to quality and design, our homes are sustainable, flexible and built to last.

Broadland Gardens is a new community comprising 10 family homes around a central green space. Every home has been individually designed by award winning local architects Clifton Emery Design to be contemporary in appearance with a focus upon the quality of the living environment.

The development is entirely gas free with homes heated and powered through renewable and low carbon technologies. All homes exceed national space standards, have a garden, two allocated parking spaces and electric vehicle charging as standard.

At Broadland Gardens we are introducing the Plymouth Home Standard; taking design inspiration from the flexibility, simplicity of form and use of materials that is characteristic of Plymouth's 19th Century housing to provide homes that are fit for now and fit for the future.

We want these homes to raise the overall bar in the standard of housing delivery in the city and demonstrate it is possible to deliver modern homes with a commitment to quality design, build and living.

# Green. Family. Future.







A view looking across the central green space.

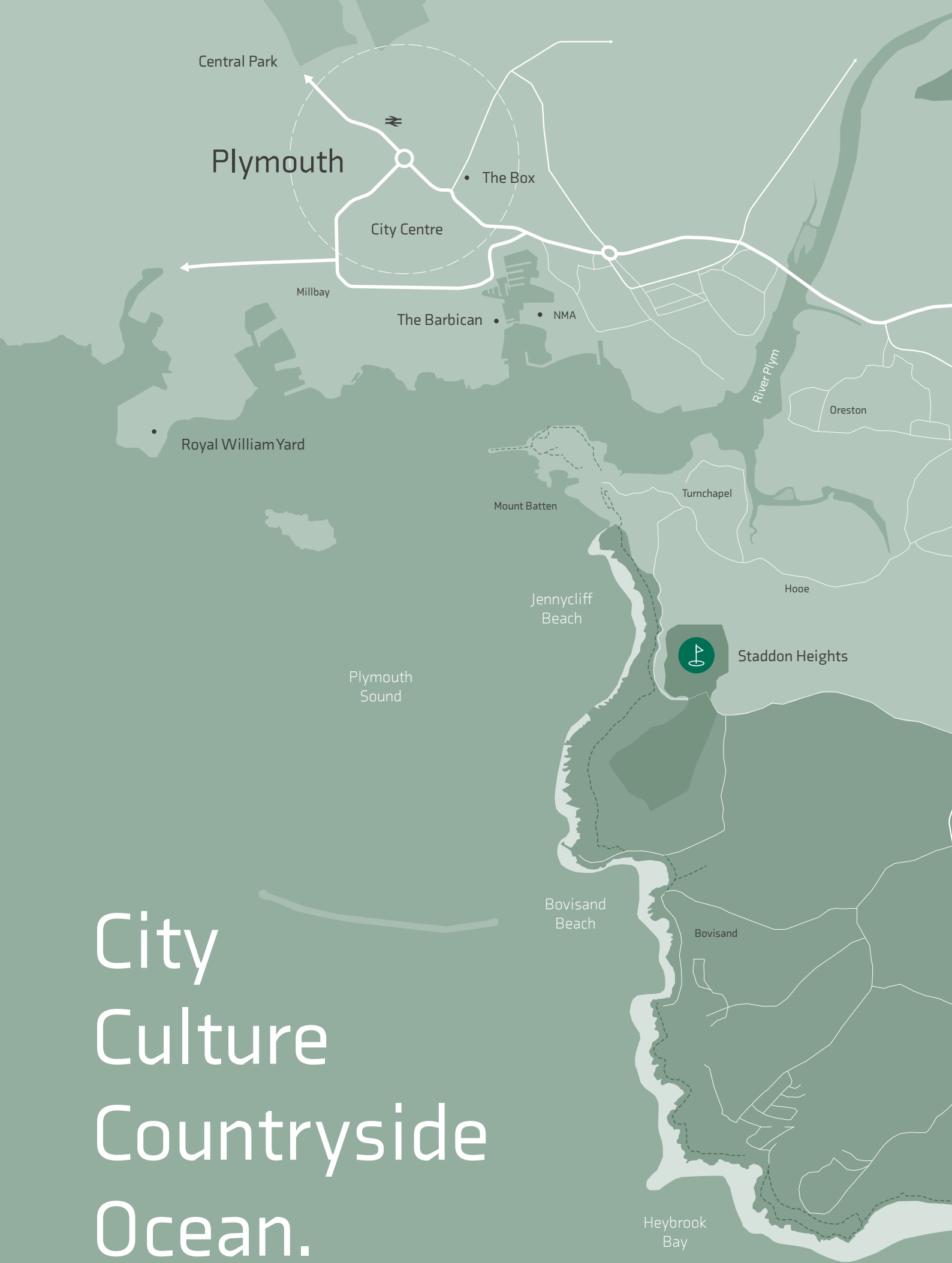

Central Park

Plymouth

• The Box

City Centre

Millbay

The Barbican •

• NMA

• Royal William Yard

River Plym

Oreston

Mount Batten

Turnchapel

Hooe

Jennycliff Beach



Staddon Heights

Plymouth Sound

Bovisand Beach

Bovisand

City  
Culture  
Countryside  
Ocean.

Heybrook Bay



Plymstock School

Pomphlett Primary School



10 mins

13 mins

A379

Brixton

Broadland Gardens is well served by public transport and is only a short drive to the vibrant city centre of Plymouth which is bustling with exciting shopping and dining and leisure opportunities - the jewel in the crown being The Royal William Yard. Other cultural offerings within Britain's Ocean City are: the award winning museum/gallery, 'The Box', The Hoe foreshore providing direct access to and stunning views over the National Marine Park of Plymouth Sound and the historic quarter of The Barbican where the UK's largest aquarium, The National Marine Aquarium (NMA) is located.

Homes in Plymstock have traditionally been in high demand, as the area benefits from easy access to the waterside, numerous opportunities for countryside and coastal walking, good public amenities, excellent sporting facilities and highly regarded primary and secondary schools. Additionally, the area is perfectly situated to explore the beautiful local beaches and quintessential market towns and villages of the South Hams, an Area of Outstanding Natural Beauty. The Dartmoor National Park, serves as a stunning backdrop to the region.

Area of Outstanding Natural Beauty

Hallacombe Hill

Wembury

Wembury Beach

Saltram Park

Billacombe

Pomphlett

Elburton

Plymstock

Goosewell

Staddiscombe

# Fit for now...

The homes have been designed to be fit for living in today with an eye to how they can be adapted to be fit for the needs of tomorrow. This means that they provide for flexible living – responding to changes in the lifestyle of occupiers over time. They are also responsibly designed so that they are energy efficient and minimise their impact on the planet.

**Flexibility.** They are great places to live for moving in straight away and can be changed in different ways to suit different requirements. Each new home is designed so that; lofts that can be easily converted to provide more living space – including the ability to add a stair to get there, living spaces can be open plan or subdivided into smaller rooms, outdoor spaces



New home

1. Open plan living
2. Bedroom
3. Spare bedroom
4. Storage
5. Loft space / storage



Growing family

1. Open plan living
2. Bedroom
3. Nursery
4. Home office
5. Loft space / storage



can be adapted for car or garden use, and the pod can be used to suit individual home owners.

**Saving the planet.** Each home has energy efficient walls and windows, good levels of insulation, light and airy interiors with big windows allowing daylight in – reducing

the need to switch lights on in the day, air source heat pumps for sustainable heating, solar panels on the roof, electric car and bike charging, manually operated vents on the roof to draw air through and cool rooms during hot weather and the ability to harvest rain water for use in the garden.



Extended family

1. Open plan living
2. Bedroom
3. Home office
4. Annex / bedroom
5. Bedroom

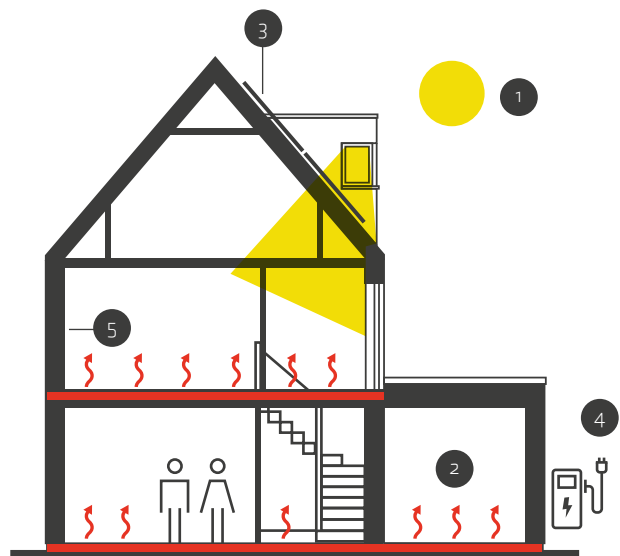

Sustainable home

1. Maximise natural light
2. Air source heat pump
3. Solar panels
4. Electric vehicle charging point
5. Fabric first - optimal insulation year-round

# Fit for the future.



# The Pod.

1. Bedroom
2. Utility / storage
3. Games room
4. Home office
5. Living room / snug

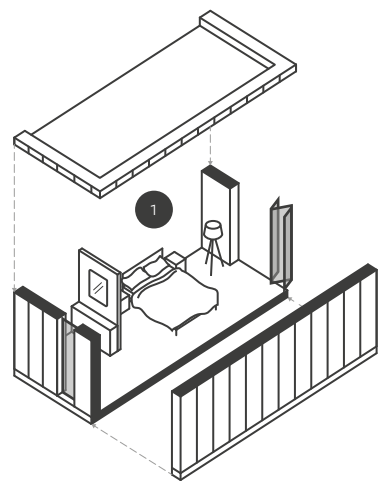
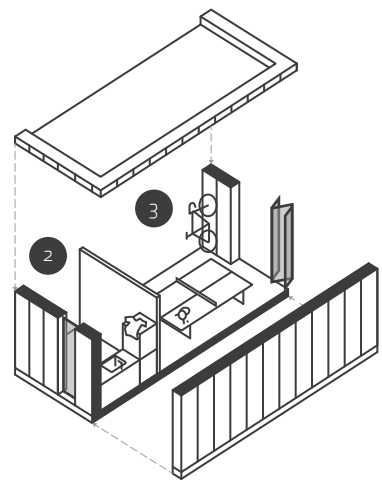
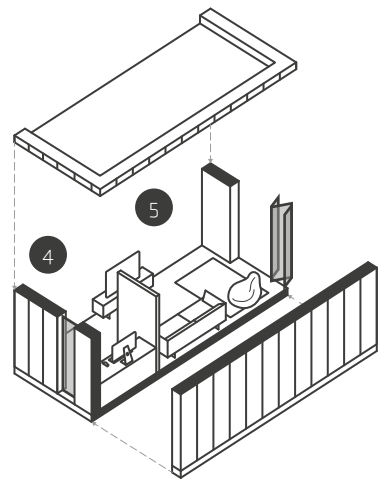

The pod is an ingenious addition to some of the homes. It allows owners to make their house fit the way they like to live. The pod is a flexible room that can be many things. It can be a music room, a library, a study, a home

office, a play room, a hobbies room, a games room, a snug, a workshop, a guest bedroom, a home cinema, a sitting room, a gym, a cycle pod. Where ever your imagination takes you – the choice is yours!









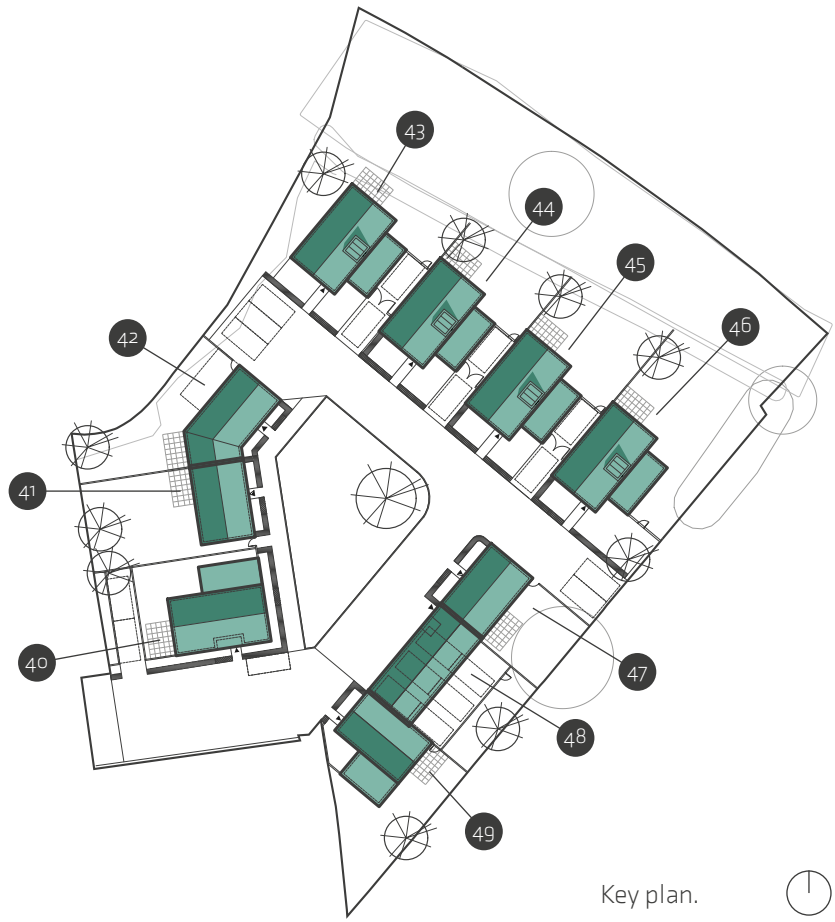





# Imagine a place...







Key plan.

- No. 40 Broadland Gardens  
 4 bed     2 spaces
  
- No. 41, 47 Broadland Gardens  
 3 bed     2 spaces
  
- No. 42 Broadland Gardens  
 4 bed     2 spaces
  
- No. 43, 44, 45, 46 Broadland Gardens  
 4 bed     2 spaces
  
- No. 48 Broadland Gardens  
 2 bed     2 spaces
  
- No. 49 Broadland Gardens  
 3 bed     2 spaces

No. 40

# Broadland Gardens.



A generously proportioned 4 bed home with a kitchen diner, separate dining/living space and downstairs WC, all accessed via the central the entrance hall. Additionally on the ground floor, 'The pod', offers additional space for flexible living and is accessed from both the entrance lobby and the garden. Upstairs accommodation includes the bedrooms and family bathroom. The master bedroom benefits from an ensuite shower room. The property benefits from 2 allocated on street parking spaces.

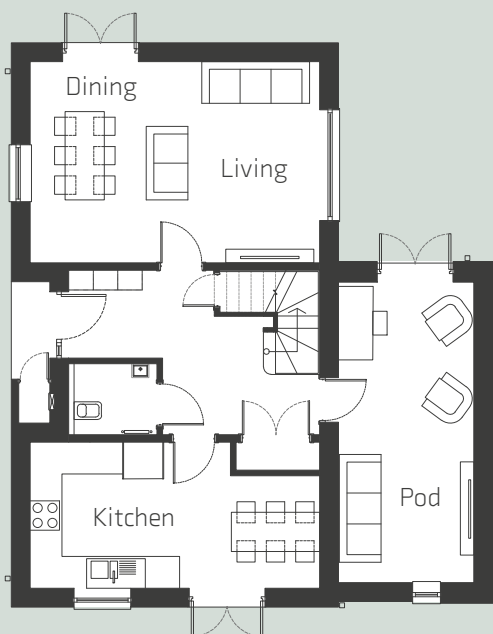
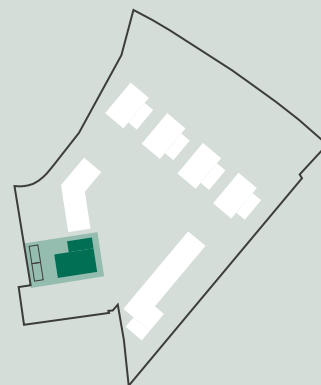

Ground Floor

**Kitchen / breakfast**  
5.90m<sup>2</sup> x 2.98m<sup>2</sup>

**Living / dining**  
5.90m<sup>2</sup> x 4.11m<sup>2</sup>

**Pod**  
2.76m<sup>2</sup> x 6.13m<sup>2</sup>

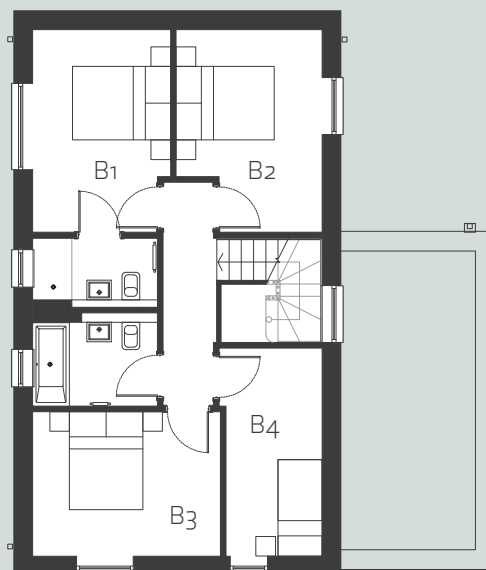

First Floor

**Bedroom 1 (B1)**  
2.82 x 4.23m<sup>2</sup>

**Bedroom 2 (B2)**  
3.83m<sup>2</sup> x 2.95m<sup>2</sup>

**Bedroom 3 (B3)**  
2.98m<sup>2</sup> x 4.23m<sup>2</sup>

**Bedroom 4 (B4)**  
1.96m<sup>2</sup> x 4.19m<sup>2</sup>

No. 41, 47

Broadland Gardens.





A generously sized 3 bed home with an open plan kitchen/dining/living area, study, utility room and downstairs WC. Upstairs features a light and airy landing leading to the bedrooms and family bathroom. The master bedroom benefits from an ensuite shower room. No 42 benefits from 2 allocated parking court spaces. No 48 benefits from 2 allocated on street parking spaces.

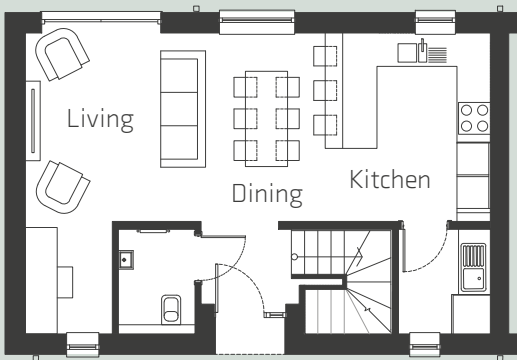

Ground Floor

Kitchen / dining  
5.38 x 3.56m<sup>2</sup>

Living  
3.65m<sup>2</sup> x 3.56m<sup>2</sup>

Study  
1.64m<sup>2</sup> x 2.13m<sup>2</sup>

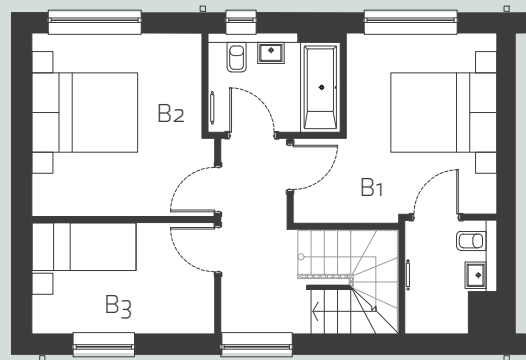

First Floor

Bedroom 1 (B1)  
2.95m<sup>2</sup> x 3.46m<sup>2</sup>

Bedroom 2 (B2)  
3.25m<sup>2</sup> x 3.05m<sup>2</sup>

Bedroom 3 (B3)  
3.49m<sup>2</sup> x 2.14m<sup>2</sup>

No. 42

# Broadland Gardens.



A spacious 4 bed home with an open plan kitchen/dining area and separate large, quirky living space and downstairs WC. Upstairs features a light and airy landing leading to the bedrooms and family bathroom. The master bedroom benefits from an ensuite shower room. The property benefits from 2 allocated on street parking spaces.

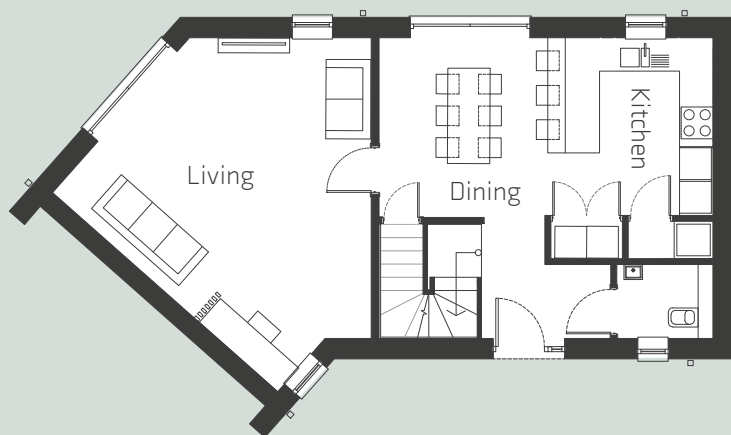

Ground Floor

**Kitchen / dining**  
6.30m<sup>2</sup> x 3.35m<sup>2</sup>

**Living**  
4.15m<sup>2</sup> x 3.55m<sup>2</sup>

**Study**  
2.90m<sup>2</sup> x 2.32m<sup>2</sup>

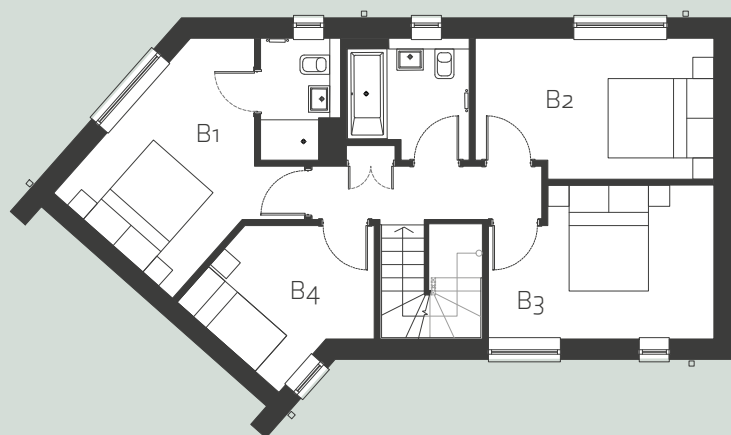

First Floor

**Bedroom 1 (B1)**  
3.90m<sup>2</sup> x 3.00m<sup>2</sup>

**Bedroom 2 (B2)**  
4.51m<sup>2</sup> x 2.66m<sup>2</sup>

**Bedroom 3 (B3)**  
2.91m<sup>2</sup> x 4.26m<sup>2</sup>

**Bedroom 4 (B4)**  
3.99m<sup>2</sup> x 2.57m<sup>2</sup>

 4 bed
  2 spaces
  128.7 m<sup>2</sup>

No. 43, 44, 45, 46  
Broadland Gardens.





A spacious 4 bed home with an open plan kitchen/dining area with access to the garden, 'the pod', utility room and downstairs WC. 'The pod' offers additional space for flexible living. Upstairs features a light and airy landing leading to the bedrooms and family bathroom. The master bedroom benefits from an ensuite shower room. These properties benefit from 2 on plot parking spaces.

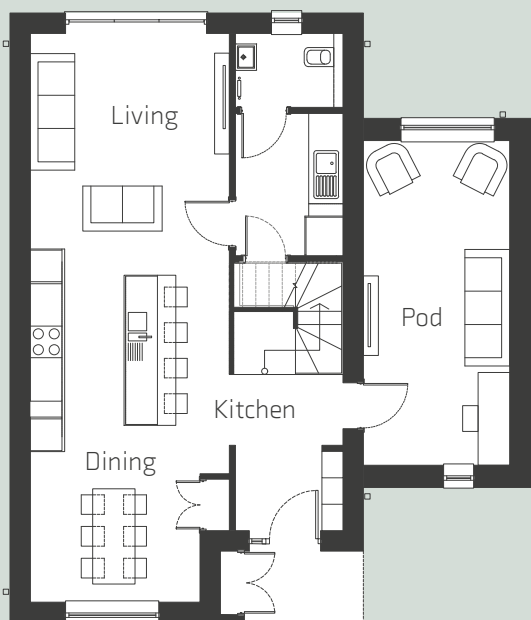
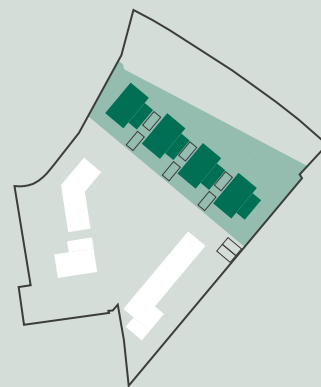

Ground Floor

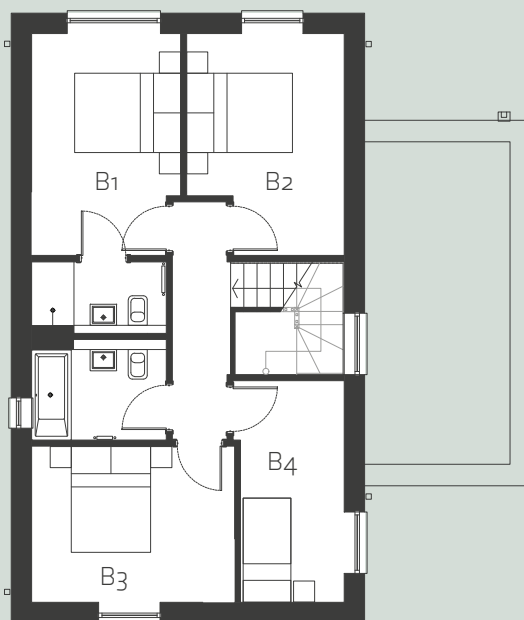

First Floor

**Kitchen**  
3.76m<sup>2</sup> x 3.82m<sup>2</sup>

**Dining**  
3.20 m<sup>2</sup> x 2.85m<sup>2</sup>

**Living**  
3.76m<sup>2</sup> x 4.08m<sup>2</sup>

**Pod**  
2.76m<sup>2</sup> x 6.13m<sup>2</sup>

**Bedroom 1 (B1)**  
2.82 x 4.23m<sup>2</sup>

**Bedroom 2 (B2)**  
3.83m<sup>2</sup> x 2.95m<sup>2</sup>

**Bedroom 3 (B3)**  
2.98m<sup>2</sup> x 4.23m<sup>2</sup>

**Bedroom 4 (B4)**  
1.96m<sup>2</sup> x 4.19m<sup>2</sup>

No. 48

# Broadland Gardens.



A spacious 2 bed coach house with a private entrance lobby, allocated parking court with 2 parking spaces and enclosed rear garden. A set of stairs leads to the modern living accommodation which comprises an open plan kitchen/living/ dining space, a study area, family bathroom and two bedrooms.

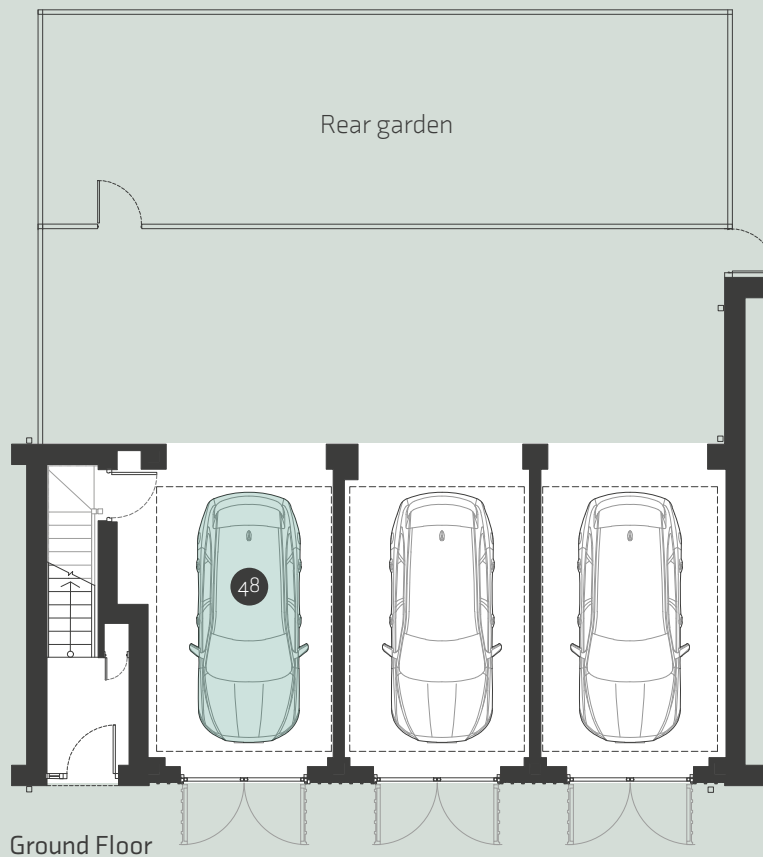
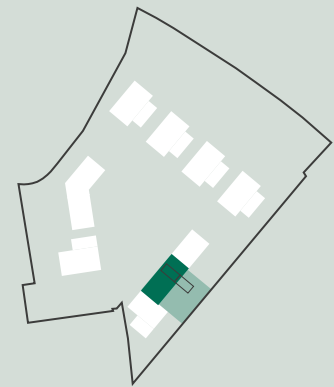

Kitchen / dining  
4.52m<sup>2</sup> x 2.77m<sup>2</sup>

Living  
5.90m<sup>2</sup> x 2.85m<sup>2</sup>

Study  
2.65m<sup>2</sup> x 1.70m<sup>2</sup>

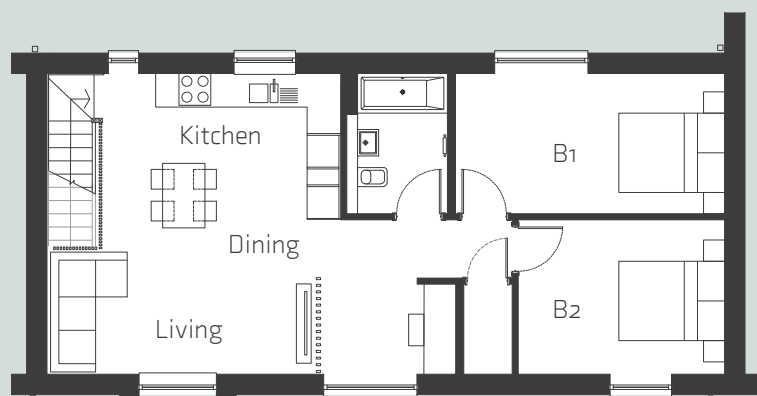

Bedroom 1 (B1)  
5.14m<sup>2</sup> x 2.69m<sup>2</sup>

Bedroom 2 (B2)  
3.94m<sup>2</sup> x 2.96m<sup>2</sup>

2 bed    2 spaces    81.1 m<sup>2</sup>

No. 49

Broadland Gardens.





A generously proportioned 3 bed home with an open plan kitchen/dining area with access to the garden and 'the pod' and a downstairs WC.

'The pod' offers additional space for flexible living. Upstairs features a light and airy landing leading to the bedrooms and family bathroom. The master bedroom benefits from an ensuite shower room and dressing room. The property benefits from 2 allocated parking court spaces.

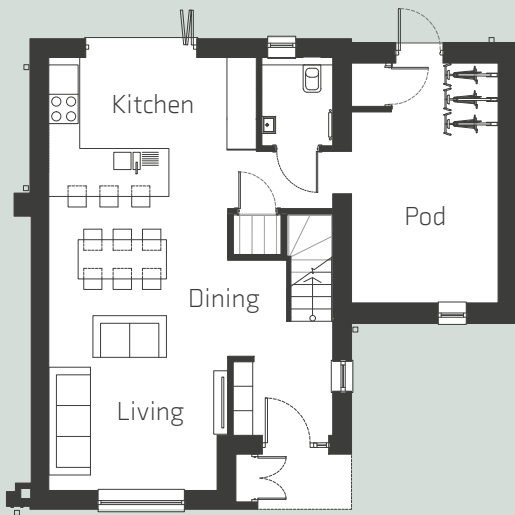
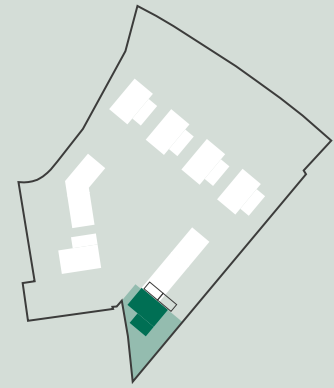

Ground Floor

Kitchen  
4.20m<sup>2</sup> x 3.05m<sup>2</sup>

Dining  
3.65 m<sup>2</sup> x 2.22m<sup>2</sup>

Living  
3.65m<sup>2</sup> x 3.55m<sup>2</sup>

Pod  
3.04m<sup>2</sup> x 4.95m<sup>2</sup>

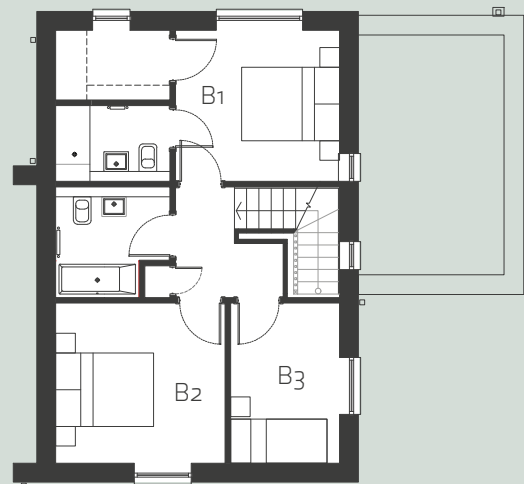

First Floor

Bedroom 1 (B1)  
3.35m<sup>2</sup> x 3.08m<sup>2</sup>

Bedroom 2 (B2)  
3.45m<sup>2</sup> x 3.26m<sup>2</sup>

Bedroom 3 (B3)  
2.23m<sup>2</sup> x 3.26m<sup>2</sup>

# Bells and whistles.





## Kitchen

- 20mm Quartz worktop with matching upstand/splashback
- Stainless steel undermounted one & half bowl sink with mixer taps
- All appliances are Caple
- Double electric oven, 4 burner induction hob and integrated extraction
- Fully integrated 50/50 fridge freezer
- Fully integrated dishwasher

## Utility Room

- 40mm laminate worktop
- Plumbing and electrics for washing machine/washer dryer
- Stainless steel sink with mixer taps

## Cloakroom

- White Roca gap sanitaryware fittings

## Family Bathroom and Ensuites

- Half height tiles to all sanitaryware walls
- Full height tiles to shower enclosure and arounds baths with shower
- Concealed thermostatic shower
- Roca Gap soft close rimless WC with concealed cistern
- Roca Gap semi pedestal washbasin with single lever mixer tap
- Electric towel rail

## Doors

- Front: Insulated bespoke timber door, 3 point locking
- Patio: Aluminium timber composite double glazed French doors

*\* Specification will vary between house types.  
Please ask your Sales Executive for details.*

Bells and whistles.







## Window

- Aluminium timber composite glazed windows

## Decoration & Finishes

- Internal walls emulsioned white
- All ceilings smooth finish emulsioned white
- Internal woodwork coated with acrylic white gloss
- Stairs: 32mm square balustrades painted white with oak handrail

## Plumbing & Heating

- Outside tap to rear gardens
- Underfloor heating to ground and first floors except for bathrooms and ensuites
- Packaged split air source heat pump

## Electrical & Lighting

- TV point in living room, main bedroom and snug
- Low energy pendant lights
- LED downlights to kitchen, dining, living, snug, utility, bathroom & ensuite
- External lights to front door and doors to rear garden
- Extractor fan to utility, bathroom & ensuites
- Mains operated smoke detectors with battery back up
- USB sockets to living area and all bedrooms
- Electric door bell push and chime

## Fascia and Rainwater Goods

- Powder coated aluminium square profile rainwater goods

## Joinery

- Bullnosed contemporary skirting and architrave
- Solid internal doors with 5 vertical panels

*\* Specification will vary between house types.  
Please ask your Sales Executive for details.*

# Does it have?

Item	No.40	No.41	No.42	No.43	No.44
<b>External</b>					
Entrance storage cupboard	<input checked="" type="checkbox"/>			<input checked="" type="checkbox"/>	<input checked="" type="checkbox"/>
Cycle storage					
Electric charging point	<input checked="" type="checkbox"/>	<input checked="" type="checkbox"/>	<input checked="" type="checkbox"/>	<input checked="" type="checkbox"/>	<input checked="" type="checkbox"/>
Pod	<input checked="" type="checkbox"/>			<input checked="" type="checkbox"/>	<input checked="" type="checkbox"/>
Solar panels	<input checked="" type="checkbox"/>	<input checked="" type="checkbox"/>	<input checked="" type="checkbox"/>	<input checked="" type="checkbox"/>	<input checked="" type="checkbox"/>
Parking spaces	2	2	2	2	2
Garage					
<b>Internal - Ground floor</b>					
Hall storage unit	<input checked="" type="checkbox"/>			<input checked="" type="checkbox"/>	<input checked="" type="checkbox"/>
Under stair cupboard	<input checked="" type="checkbox"/>		<input checked="" type="checkbox"/>	<input checked="" type="checkbox"/>	<input checked="" type="checkbox"/>
Utility		<input checked="" type="checkbox"/>		<input checked="" type="checkbox"/>	<input checked="" type="checkbox"/>
Study/ home office	<input checked="" type="checkbox"/>	<input checked="" type="checkbox"/>	<input checked="" type="checkbox"/>	<input checked="" type="checkbox"/>	<input checked="" type="checkbox"/>
<b>Internal - First floor</b>					
Bedroom 1 - En-suite	<input checked="" type="checkbox"/>		<input checked="" type="checkbox"/>	<input checked="" type="checkbox"/>	<input checked="" type="checkbox"/>
Bedroom 1 - Walk in wardrobe					

No.45	No.46	No.47	No.48	No.49	Notes
<input checked="" type="checkbox"/>	<input checked="" type="checkbox"/>			<input checked="" type="checkbox"/>	
				<input checked="" type="checkbox"/>	
<input checked="" type="checkbox"/>	<input checked="" type="checkbox"/>	<input checked="" type="checkbox"/>	<input checked="" type="checkbox"/>	<input checked="" type="checkbox"/>	
<input checked="" type="checkbox"/>	<input checked="" type="checkbox"/>			<input checked="" type="checkbox"/>	Adaptable space for any use
<input checked="" type="checkbox"/>	<input checked="" type="checkbox"/>	<input checked="" type="checkbox"/>	<input checked="" type="checkbox"/>	<input checked="" type="checkbox"/>	
2	2	1	1	1	
		<input checked="" type="checkbox"/>	<input checked="" type="checkbox"/>	<input checked="" type="checkbox"/>	Garage spaces are within No. 48
<input checked="" type="checkbox"/>	<input checked="" type="checkbox"/>			<input checked="" type="checkbox"/>	
<input checked="" type="checkbox"/>	<input checked="" type="checkbox"/>		<input checked="" type="checkbox"/>	<input checked="" type="checkbox"/>	
<input checked="" type="checkbox"/>	<input checked="" type="checkbox"/>	<input checked="" type="checkbox"/>			
<input checked="" type="checkbox"/>	<input checked="" type="checkbox"/>	<input checked="" type="checkbox"/>	<input checked="" type="checkbox"/>		
<input checked="" type="checkbox"/>	<input checked="" type="checkbox"/>			<input checked="" type="checkbox"/>	
				<input checked="" type="checkbox"/>	

# Notes.

---

---

---

---

---

---

---

---

---

---

---

---

---

---

---

---

---

---

---

---

---

---

---

---

---

---

---

---

---

---

General notes:  
Statements contained within this brochure are believed to be correct at time of print. They are not to be regarded as statements or representations of fact; neither the selling agents nor Plymouth City Council guarantee their accuracy. This brochure does not form part of any contract.  
\*The computer generated images are for illustrative purposes only, and are intended to serve as a general guide to the appearance of the properties.

All photographs are for indicative purposes only. It may be necessary, and rights are reserved, for developer to make alterations to the specification, layout and appearance of the development at any time without formal notice. Please refer to a sales representative for elevation and landscape details.

Maps show approximate locations and are not to scale.





**Get in touch:**

For more information about the new homes at Broadland Gardens please visit your local sales office, call or email.

6 The Broadway  
Plymstock  
Plymouth  
PL9 7AU

01752 278499  
newhomes@langtownandcountry.com

[www.langtownandcountry.com](http://www.langtownandcountry.com)



CliftonEmerydesign

EST 1947  
Gates  
CONSULTANTS

 Classic Builders